

LCN 7900 SERIES CONTROL BOX ACCESSORIES

AIR FILTER, -329

Replacement inlet air filter for 7981 or 7982 series control boxes.

329



AIR FILTER, -329G

Replacement inlet air filter assembly for 7901 or 7902 series control boxes.

329G

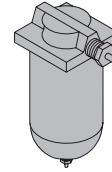

FILTER AND SEAL, -929

Internal filter and seal component to the Air Filter -329G assembly.

929

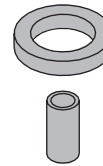

RELAY, -390

Single pole, double throw (SPDT) relay only for 7901, 7902, 7981, or 7982 series control boxes.

390 (A & B)
390C

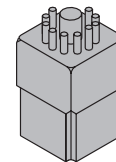

RELAY, -390C

Double pole, double throw (DPDT) relay only for 7949 series blow open control box.

POWER SUPPLY BOARD, -900

Main power supply/input board for the 7901, 7902, 7981, or 7982 series control boxes.

900

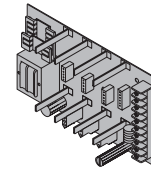

TIMER CARD, -903

0 to 30 second timer module. Plugs into the power supply board, -900. 7901 (A slot) series control box requires 1 each. 7902 (A/B slots) and 7981 (P/A slots) series control boxes require 2 each. 7982 (P/A/B slots) series control box requires 3 each.

903

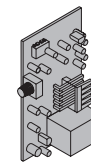

SEQUENCER CARD, -3426

Dual, 0 to 30-second sequence timer module for 7902 and 7982 series control boxes. Can be added to a standard 7902 or 7982 series control box to convert to a sequential operation. Sequencer card, -3426 is included when ordering a 7902S or 7982S series control box.

3426

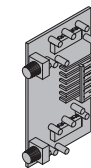

LCN 7900 SERIES CONTROL BOX ACCESSORIES

VALVE ASSEMBLY, -941

Regulator valve assembly for 7901 series control box.

VALVE ASSEMBLY, -942

Regulator valve assembly for 7902 series control box.

VALVE ASSEMBLY, -941C

Regulator valve assembly for 7949 series blow open control box.

SOLENOID VALVE ASSEMBLY, -3299A

Air valve assembly for 7981 series control box or the 'A' circuit valve assembly for the 7982 series control box.

SOLENOID VALVE ASSEMBLY, -3299B

Air valve assembly for the 'B' circuit in the 7982 series control box.

RELAY PACKAGE 'A', -3390A

ES relay assembly for 7901 and 7981 series control boxes or the 'A' circuit ES relay assembly in a 7902 or 7982 series control boxes. Includes -390 relay, base, and wires. Can be added to standard 7901, 7902, 7981, or 7982 series control boxes to convert to ES operation. Relay package, -3390A is included when ordering a 7901ES, 7902ES, 7981ES, or 7982ES series control box.

RELAY PACKAGE 'B', -3390B

ES relay assembly for 'B' circuit in 7902 or 7982 series control boxes. Includes -390 relay, base, and wires. Can be added to standard 7902 or 7982 series control boxes to convert to ES operation.

Relay package, -3390B is included when ordering a 7902ES or 7982ES series control box.

RELAY PACKAGE 'C', -3390C

ES relay assembly in 7949 series blow open control box.

Includes -390C relay, base, and wires.

Can be added to standard 7949 series blow open control box to convert to ES operation.

Relay package, -3390C is included when ordering a 7949ES series control box.

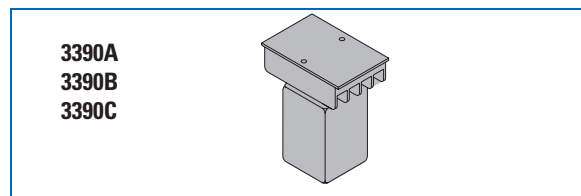
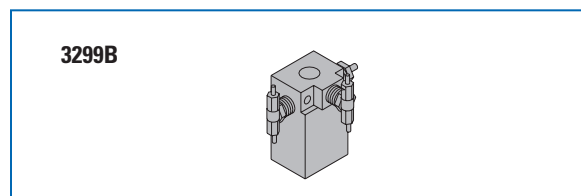
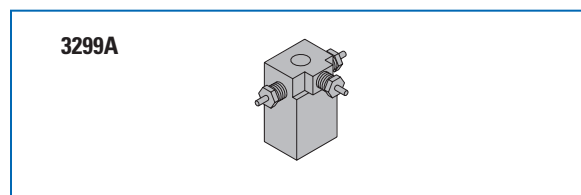
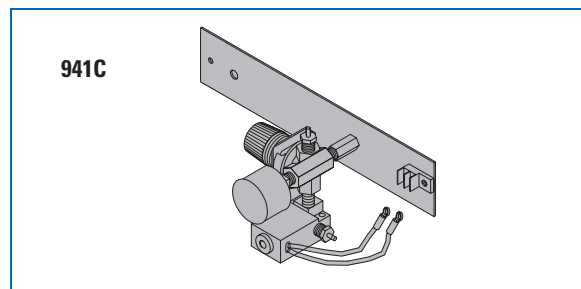
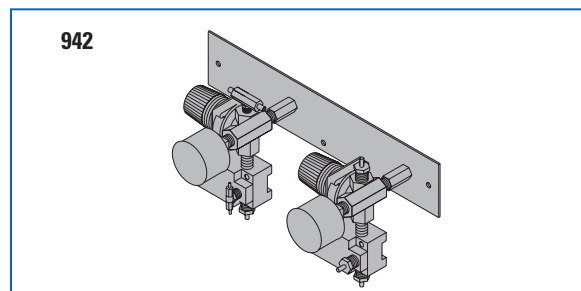
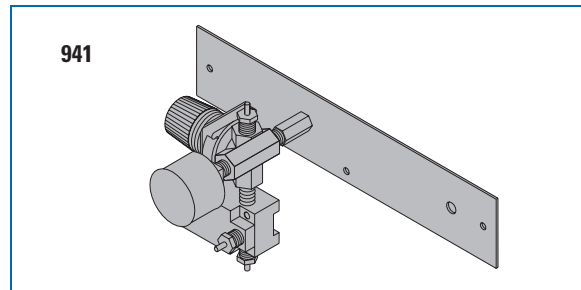

LCN 7900 SERIES CONTROL BOX ACCESSORIES

ISOLATOR, -962

Rubber Isolators for 7981/7982 compressor assembly, -3960.

962



MUFFLER, -293G

Exhaust muffler for 7901, 7902, 7949, 7981, and 7982 series control boxes.

293G



COMPRESSOR ASSEMBLY, -3960

Internal air pump assembly for 7981 or 7982 series control box. Includes starter capacitor, -962 Isolators, and -329 air filter.

3960

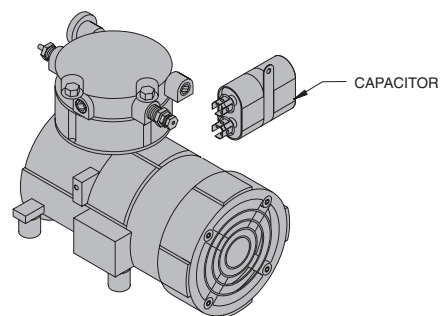

COMPRESSOR SERVICE KIT, -3592

Internal components for pressure release valve on -3960 Compressor Assembly.

3592

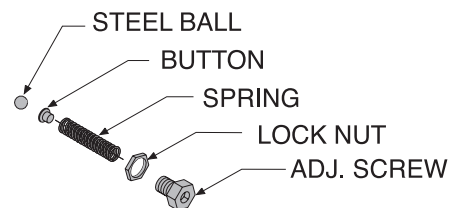

PNEUMATIC TUBING, 7910-925

1/8" (3mm) I.D. flexible pneumatic tubing for use with standard barbed fittings provided on pneumatic control boxes and operators. Order by linear footage required. 7910-925 tubing is not fire-rated. Contact LCN for applications where tubing must run through rated plenums.

7910-925

