

LCN 4210T SERIES

FEATURES



The 4210T SMOOTHIE® Series is a heavy duty, high security track closer with special components to minimize tampering and vandalism. Forged steel arms and heavy gauge metal security covers are designed for correctional, vandal prone, institutional and other high traffic interior applications. The closer has passed 10,000,000 cycles in independent testing. A choice of finishes and cylinder functions meet correctional and vandal resistant requirements.

- ▶ Standard 4210T series closer shipped with standard arm, security track (non hold-open), metal security cover, and TORX Machine Screw pack. See 4210T Series page 13 for options.
- ▶ Sized cylinders for interior doors to 4'0".
- ▶ Closer mounts on push side of the door, track mounts to frame stop. Specify right or left swinging door.
- ▶ 4211T cylinder meets ADA requirements. See 4210T Series page 14.
- ▶ Standard or optional custom powder coat finish.
- ▶ Optional SRI primer for installations in corrosive conditions.
- ▶ The 4210T Series is UL listed for self-closing doors.
- ▶ Tested and certified under ANSI Standard A156.4, grade one.

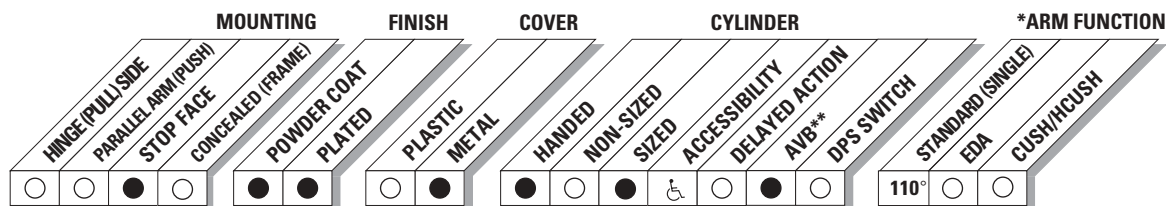

- Available
- Not available

♿ Closer available with less than 5.0 lbs. opening force on 36" door.
 *Maximum opening with standard template.
 ** Advanced Variable Backcheck

LCN 4210T SERIES

MOUNTING DETAILS

STOP FACE (PUSH SIDE) MOUNTING

MAXIMUM OPENING

Templating allows 110°.

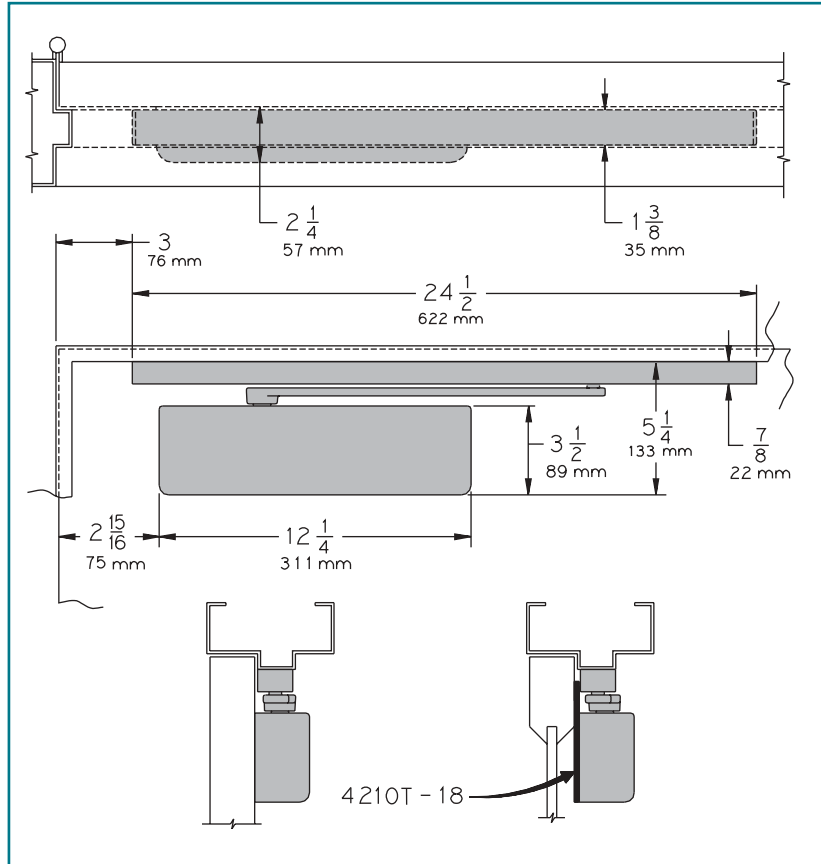

- ▶ **Butt Hinges** should not exceed 5" (127 mm) in width.
- ▶ **Auxiliary Stop** is recommended where the door cannot swing 110°.
- ▶ **Clearance** is 2 1/4" (57 mm) from door.
- ▶ **Top Rail** less than 5 1/4" (133 mm) measured from stop, requires PLATE 4210T-18. Plate requires 2 1/4" (57mm) minimum measured from the stop.
- ▶ **Stop Width** minimum 1 3/8" (35 mm).
- ▶ **Advanced Variable Backcheck** cylinder starts backcheck at approximately 45° instead of the normal 75°. Add suffix "AVB" to selected cylinder (eg. 4213T AVB).

Options

- ▶ Advanced Variable Backcheck cylinder.

Special Templates

Customized installation templates or products may be available to solve unusual applications. Contact LCN for assistance.

CYLINDERS

CYLINDER, 4210T-3071

Standard, handed cast iron cylinder assembly. For various applications see "Table of Sizes" on 4210T Series page 14.

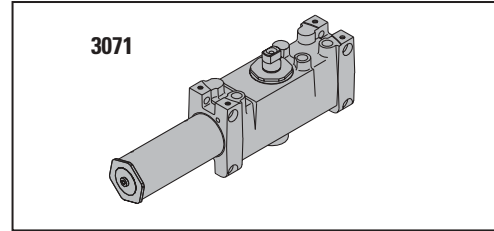

COVER

SECURITY COVER, 4210T-72MC

Handed, heavy gauge metal security cover.
Four point TORX mounting for extra security.
Closer adjustments not accessible with cover installed.

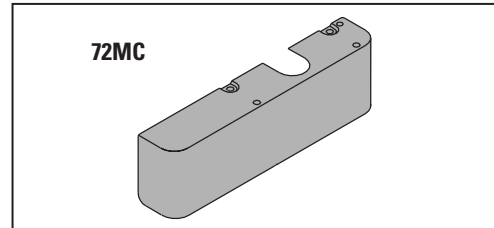

ARM

STANDARD SECURITY ARM, 4210T-3077T

Handed arm closer features solid forged steel, large cross section arm.
Special threaded attachment of track roller for extra security.
Double slab arm/pinion attachment for maximum strength.
Can only be used with high security track roller, 4210T-3034.
Roller is included with arm when 4210T-3077T is ordered separately.

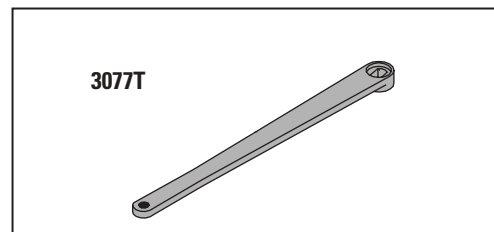

TRACK

SECURITY TRACK, 4210T-3038

Non-handed, high security track.
Designed to eject foreign objects placed in track during either opening or closing motion.
Requires track roller, 4210T-3034.

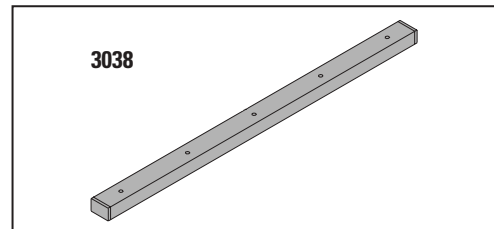

SECURITY TRACK ROLLER, 4210T-3034

Low friction track roller threads into 4210T-3077 arm for extra strength and security.
Can not be removed without disconnecting arm from closer.

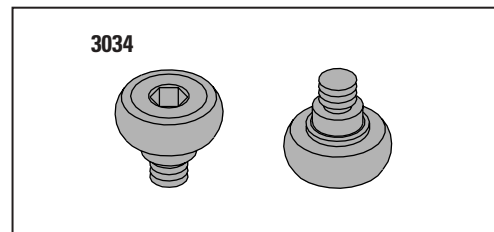

INSTALLATION ACCESSORIES

PLATE, 4210T-18

Required where top rail, when measured from the stop, is less than 5 1/4" (133 mm).
Plate requires 2 1/4" (57 mm) minimum top rail measured from the stop.

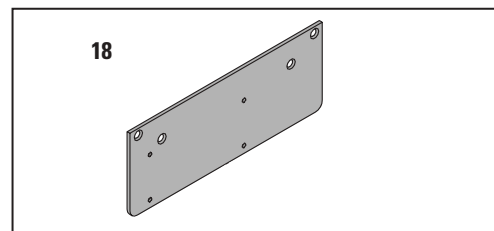

LCN 4210T SERIES

TABLE OF SIZES Select closer based on width of door.
4210T series cylinders available in size 1, 3 or 4.
Closing power of all 4210T Series closers may be increased 15%.

→ Indicates recommended range of door width for closer size.
Note: Minimum door width 30" (762mm).

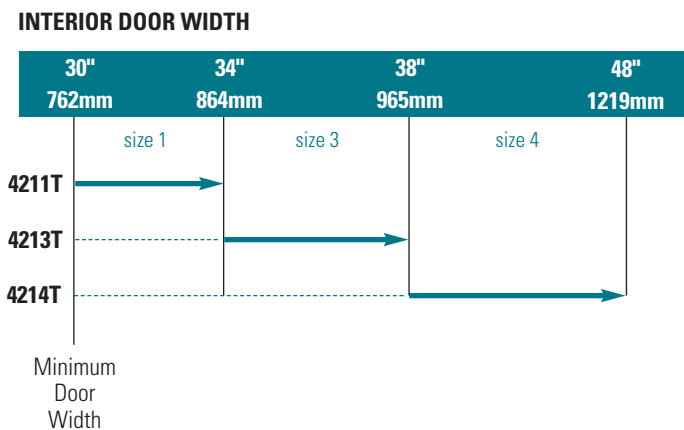

REDUCED OPENING FORCE 4210T CLOSERS

CAUTION ! Any manual door closer, including those certified by BHMA to conform to ANSI Standard A156.4, that is selected, installed and adjusted based on ADA or other reduced opening force requirements may not provide sufficient power to reliably close and latch a door.

Refer to POWER OPERATORS section for information on systems that meet reduced opening force requirements without effecting closing power.

	DOOR WIDTH	36"	42"	48"
	8.5* lbs.	4213T	4213T	4213T
5.0* lbs.	4211T	4211T	4211T	

* Maximum opening force

HOW-TO-ORDER 4210T SERIES CLOSERS

1. SELECT CYLINDER SIZE

- 4211T (ADA)
- 4213T
- 4214T

2. SPECIFY HAND

- RH
- LH

3. SELECT FINISH

- Standard Powder Coat _____
Aluminum, Dark Bronze, Tan, Statuary,
Light Bronze, Black, Brass.

Closer will be shipped with:

- SECURITY COVER,
 - STANDARD SECURITY ARM,
 - SECURITY TRACK ROLLER,
 - SECURITY TRACK,
 - TORX MACHINE SCREW PACK,
- unless options listed below are selected.

CLOSER OPTIONS

CYLINDER

- Advanced Variable Backcheck (AVB)

FINISH

- Custom Powder Coat (RAL) _____
- Plated Finish, US _____
- SRI primer

SCREW PACK

- TB* and TORX Machine Screw (TBTRX)

* Specify door thickness if other than 1 3/4".

INSTALLATION ACCESSORIES

- PLATE, 4210T-18

SPECIAL TEMPLATE

- ST- _____

NOTE: Installation of this closer requires T-27 and T-25 driver bits for TORX machine screws with a security pin. Sold separately.

