

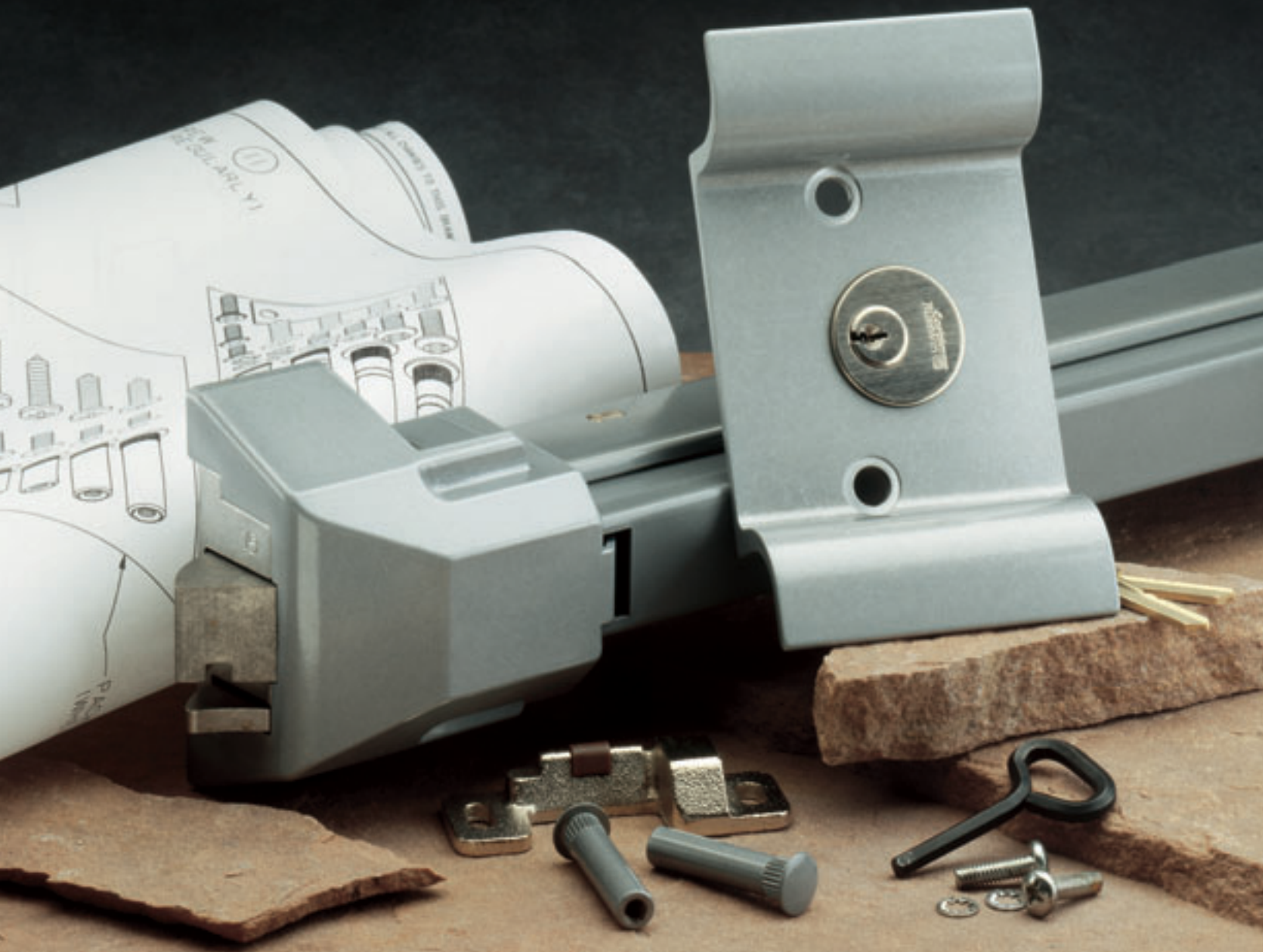

Pushpad Exit Devices

ED8000 Series



An ASSA ABLOY Group company

ASSA ABLOY

ED8000 Series

Applications

Heavy-duty steel construction and Grade 1 performance, priced for outstanding value. Meets rigorous life safety and security requirements, while offering pleasing aesthetics and trouble-free operation. Designed for high-use, high-abuse situations, ED8000 Pushpad Exit Devices can be teamed with a variety of Corbin Russwin trims to provide desired functions, styles and finishes in new construction and renovations, including these settings:

- School and University
- Health Care
- Government and Public
- Commercial and Industrial
- Office and Retail
- Transportation and Utilities
- Hotels and Conference Centers
- Religious

Advantages

- Meets ANSI Grade 1 requirements
- Easy-to-use pushpad for quick egress and ADA compliance
- Heavy-duty steel construction
- 3/4" latchbolt standard on rim device
- Low profile and projection for barrier-free code compliance
- No projecting parts to inhibit egress
- Devices accommodate various trim functions for flexibility
- Wide range of trim styles and finishes to match other Corbin Russwin products
- One-point dogging standard on panic-listed devices
- Devices available to satisfy C-UL US safety and fire requirements



Introduction	2
Applications and Listings	3
Rim Exit Features	4
Surface Vertical Rod Exit Features	6
Rim/Vertical Rod Trims & Functions	8
Options & Accessories	11
Cylinders	12
Mullions	13
Electrified Options	14
How to Order	15
Quick Codes	16
Helpful Terms	17
How to Specify	18

This catalog can be found on the Internet at the Corbin Russwin website at: www.corbinruswin.com

ED8000 Series Pushpad Exit Devices

Applications and Listings

WHI Listed by Warnock Hersey International Inc., as fire exit hardware.

C-UL US Listed by Underwriters Laboratories Inc., as fire exit hardware.

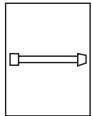
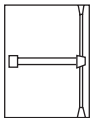
Single Door	Listing	Maximum Opening	Application	
Rim ED8200 ED8200B ED8200A	Panic 1-1/2 Hr. WHI 3 Hr. UL	4' x 10'* 4' x 8' 4' x 8'	Surface applied; single point latching.	
Surface Vertical Rod ED8400	Panic	4' x 10'	Surface applied; two point latching.	

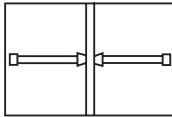
Pair of Doors with Removable Mullion	Listing	Maximum Opening	Application	
Rim x Rim ED8200 x ED8200 x 510/710 ED8200B x ED8200B x 508/708A ED8200A x ED8200A x 508/708A	Panic 1-1/2 Hr. WHI 3 Hr. UL	8' x 10' 8' x 8' 8' x 8'	2 independent active doors with removable mullion.	

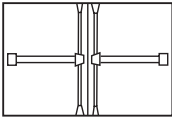
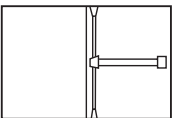
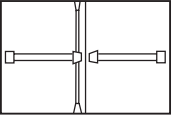
Pair of Doors	Listing	Maximum Opening	Application	
Surface Vertical Rod x Surface Vertical Rod ED8400 x ED8400 ED8400A x ED8400A	Panic 1-1/2 Hr. UL	8' x 10' 8' x 8'	2 independent doors with 2 point latching, swinging in the same direction. Overlapping astragal may not be required.	
Surface Vertical Rod x Surface Vertical Rod (Double Egress) ED8400 x ED8400 ED8400A x ED8400A	Panic 3 Hr. UL	8' x 10' 8' x 8'	2 independent doors with 2 point latching, swinging in opposite directions. Overlapping astragal required for 3-hour openings.	
Surface Vertical Rod x Rim ED8400 x ED8200 x S02	Panic	8' x 10'	S02 strike required on inactive door; coordinator recommended.	

Note: All ED8000 Series Pushpad Exit Devices are UL305 panic listed.

*UL does not set a door height limitation on panic applications.

ED8200 Panic Listed Rim Exit Device
ED8200B 1-1/2 Hour Fire Listed Rim Exit Device
ED8200A 3-Hour Fire Listed Rim Exit Device



Features

Handing

Non-handed.

Bar Length

Easily field cut to size.

Standard: 36" bar fits 31" - 36" (787mm-914mm) door.

Optional: 30" bar fits 28" - 30" (711mm-762mm) door; specify W030.

Optional: 42" bar fits 37" - 42" (940mm-1067mm) door; specify W042.

Optional: 48" bar fits 43" - 48" (1092mm-1219mm) door; specify W048.

Door Thickness

1-3/4" (44mm) standard.

Optional: 2" (51mm); specify D200.

Optional: 2-1/4" (57mm); specify D214.

Backset

2-3/4" (70mm). Device and trim cover standard ANSI A115.2 (Type 161) cylindrical lock preparation. (Backset changes when mullion is used.)

Stile

Minimum width 5" (127mm).

Projection

2-1/2" (64mm) low profile for barrier-free access.

Latchbolt

3/4" (19mm) stainless steel pullman-type with stainless steel deadlocking latch.

Materials

Heavy-duty wrought steel chassis and pushpad; aluminum front and rear bar covers; stainless steel springs; nylon bearings.

Dogging

Standard on ED8200 devices: single point 1/4 turn dogging.

Optional: less dogging; specify M51.

Dogging not available on ED8200A and ED8200B devices.

Fasteners

Standard on ED8200 devices: machine screws and wood door fasteners.

Optional on ED8200 devices: sex nuts and bolts; specify M54.

Standard on ED8200A and ED8200B devices: sex nuts and bolts.

Strike

See Options and Accessories, page 11.

Functions and Trims

Thru-bolted lever, pull and knob trims available with wide range of functions; see Trims and Functions, pages 8-10.

Cylinders

Cylinder not included unless specified.

See Quick Codes, page 16.

Removable Mullion

See Mullions, page 13.

Shim Kit

Optional for mounting device over glass bead vision light; specify M58.

Applications and Listings

See page 3.

Exit Alarm

Optional on ED8200 and ED8200B devices, with and without delay feature. See

Electrified Options, page 14, or Quick Codes, page 16.

Warranty

One-year limited.

Certification/Compliance

ANSI

Meets A156.3, Type 1, Grade 1.

Meets A117.1 Accessibility Code.

C-UL US

All devices listed for safety as panic hardware; devices comply with UL 305 standards for panic hardware. UL symbol on rear cover label indicates listing. Three-hour fire-rated devices listed as fire exit hardware for A label and lesser class 4' x 8' single or 8' x 8' double doors; UL symbol on rear cover label indicates listing.

Warnock Hersey International Inc.

ED8200B listed as fire exit hardware for installation on up to 1-1/2 hour fire doors, up to 8' x 8'.

California State Reference Code

This product has been approved by the California State Fire Marshal (CSFM) pursuant to Section 13144.1 of the California Health and Safety Code.

NFPA

All exit devices comply with NFPA 101 Life Safety Code. All fire-rated devices comply with NFPA 80 Fire Doors and Windows.

ADA

Exit devices, lever trims and pulls comply with Americans with Disabilities Act.

Finishes

Painted finishes available on devices and some trims.

BHMA 689 Silver Aluminum Painted

BHMA 690 Dark Bronze Painted

BHMA 691 Light Bronze Painted

Plated finishes available on trims only.

BHMA 605 Bright Brass

BHMA 606 Satin Brass

BHMA 611 Bright Bronze

BHMA 612 Satin Bronze

BHMA 613 Dark Oxidized Satin Bronze, Oil Rubbed

BHMA 622 Flat Black Coated

BHMA 625 Bright Chromium Plated

BHMA 626 Satin Chromium Plated

**ED8200 and ED8200B
Rim Exit Devices**

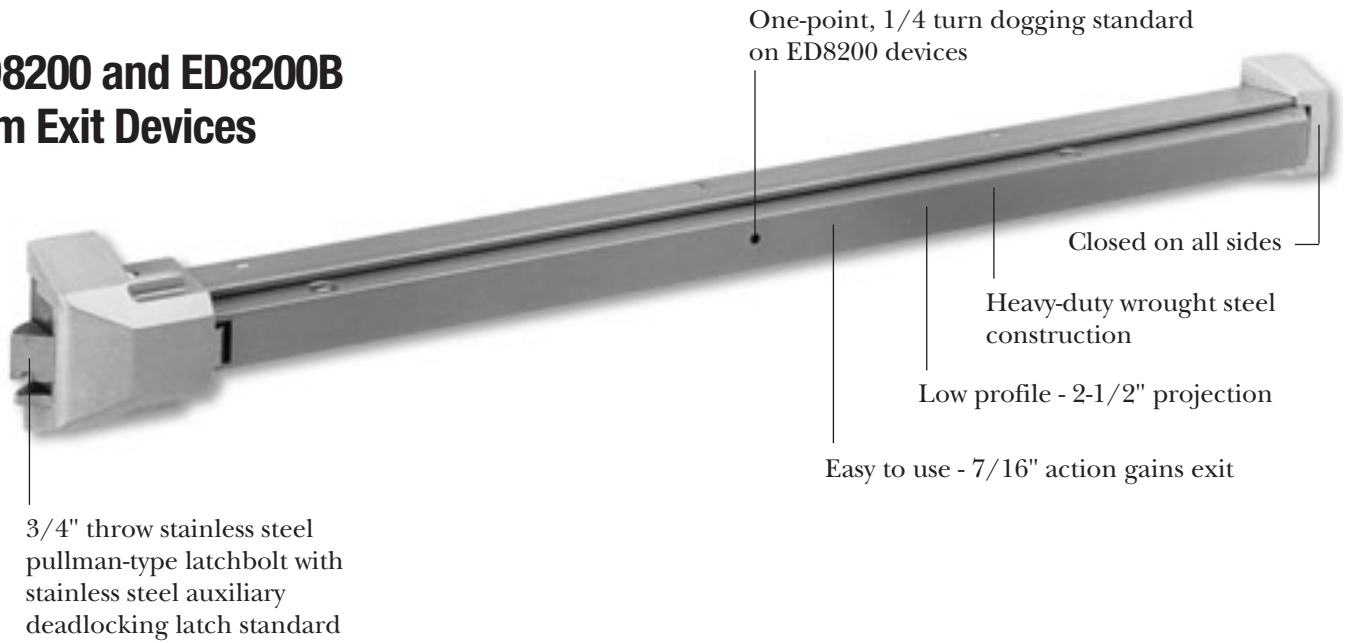

**ED8200A Rim
Exit Device**

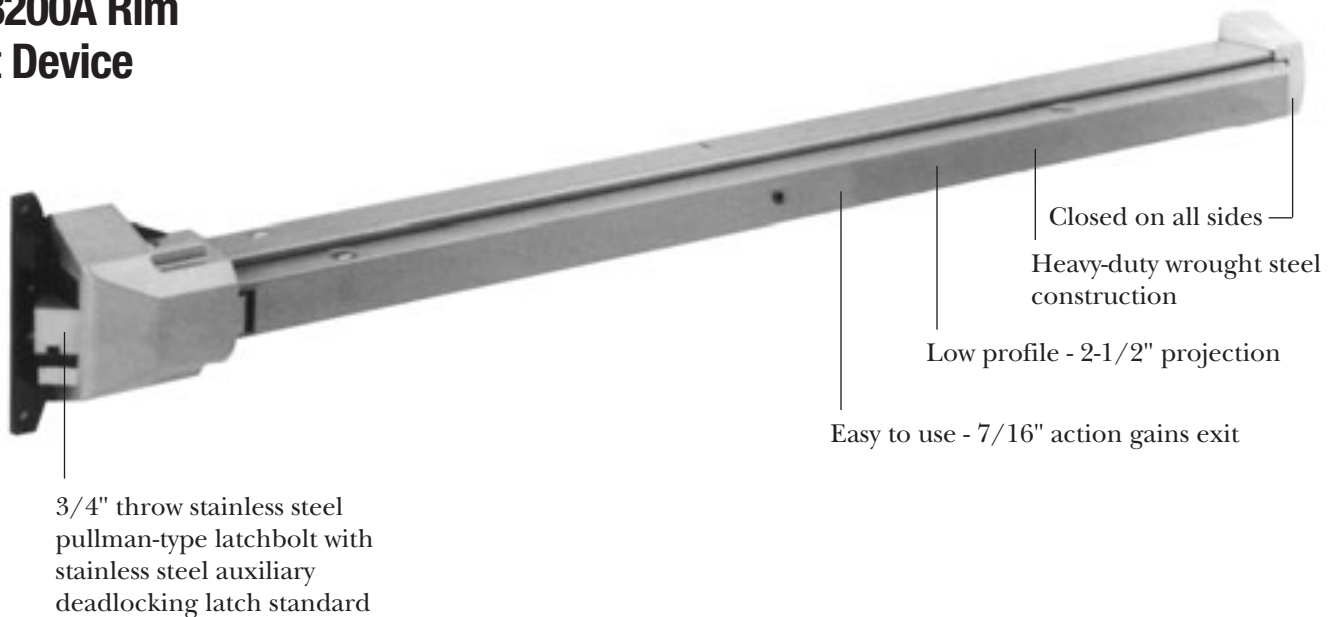

ED8400 Panic Listed Surface Vertical Rod Exit Device

ED8400A 3-Hour Fire Listed Surface Vertical Rod Exit Device

Features

Handing

Handed; specify hand.

Bar Length

Easily field cut to size.

Standard: 36" bar fits 31" - 36"
(787mm-914mm) door.

Optional: 30" bar fits 28" - 30"
(711mm-762mm) door; specify W030.

Optional: 42" bar fits 37" - 42"
(940mm-1067mm) door; specify W042.

Optional: 48" bar fits 43" - 48"
(1092mm-1219mm) door; specify W048.

Door Thickness

1-3/4" (44mm) standard.

Optional: 2" (51mm); specify D200.

Optional: 2-1/4" (57mm); specify D214.

Backset

2-3/4" (70mm). Device and trim cover standard ANSI A115.2 (Type 161) cylindrical lock preparation.

Stile

Minimum width 5" (127mm).

Door Height

All top rods easily field cut to size.

Standard on ED8400 devices: top rod for 7'6" door.

Optional on ED8400 devices: top rod for doors up to 10'; specify H1000.

Standard on ED8400A devices: top rod for 8' door.

Projection

2-1/2" (64mm) low profile for barrier-free access.

Latchbolts

ED8400 devices:

Top: 1/2" interlocking drop latch.

Bottom: 5/8" pivoted.

ED8400A devices:

Top: 3/4" (19mm) steel pullman type with steel deadlocking latch. Bottom: 3/4"

(19mm) deadbolt.

Vertical Rods

Inverted U-shaped rectangular.

Materials

Heavy-duty wrought steel chassis and pushpad; steel vertical rods; aluminum bar and latch covers; stainless steel springs; nylon bearings.

Dogging

Standard on ED8400 devices: single point 1/4 turn dogging.

Optional: less dogging; specify M51.

Dogging not available on ED8400A devices.

Fasteners

Standard on ED8400 devices: machine screws and wood door fasteners.

Optional on ED8400 devices: sex nuts and bolts; specify M54.

Standard on ED8400A devices: sex nuts and bolts.

Strike

See Options and Accessories, page 11.

Functions and Trims

Thru-bolted lever, pull and knob trims available with wide range of functions; see Trims and Functions, pages 8-10.

Cylinders

Cylinder not included unless specified.

See Quick Codes, page 16.

Applications and Listings

See page 3.

Shim Kit

Optional for mounting device over glass bead vision light; specify M58.

Warranty

One-year limited.

Certification/Compliance

ANSI

Meets A156.3, Type 2, Grade 1.

C-UL US

All devices listed for safety as panic hardware; devices comply with UL 305 standards for panic hardware. UL symbol on rear cover label indicates listing. Three-hour fire-rated devices listed as fire exit hardware for A label and lesser class 8' x 8' double doors; UL symbol on rear cover label indicates listing.

California State Reference Code

This product has been approved by the California State Fire Marshal (CSFM) pursuant to Section 13144.1 of the California Health and Safety Code.

NFPA

All exit devices comply with NFPA 101 Life Safety Code. All fire-rated devices comply with NFPA 80 Fire Doors and Windows.

ADA

Lever trims and pulls comply with Americans with Disabilities Act.

Finishes

Painted finishes available on devices and some trims.

BHMA 689 Silver Aluminum Painted

BHMA 690 Dark Bronze Painted

BHMA 691 Light Bronze Painted

Plated finishes available on trims only.

BHMA 605 Bright Brass

BHMA 606 Satin Brass

BHMA 611 Bright Bronze

BHMA 612 Satin Bronze

BHMA 613 Dark Oxidized Satin Bronze, Oil Rubbed

BHMA 622 Flat Black Coated

BHMA 625 Bright Chromium Plated





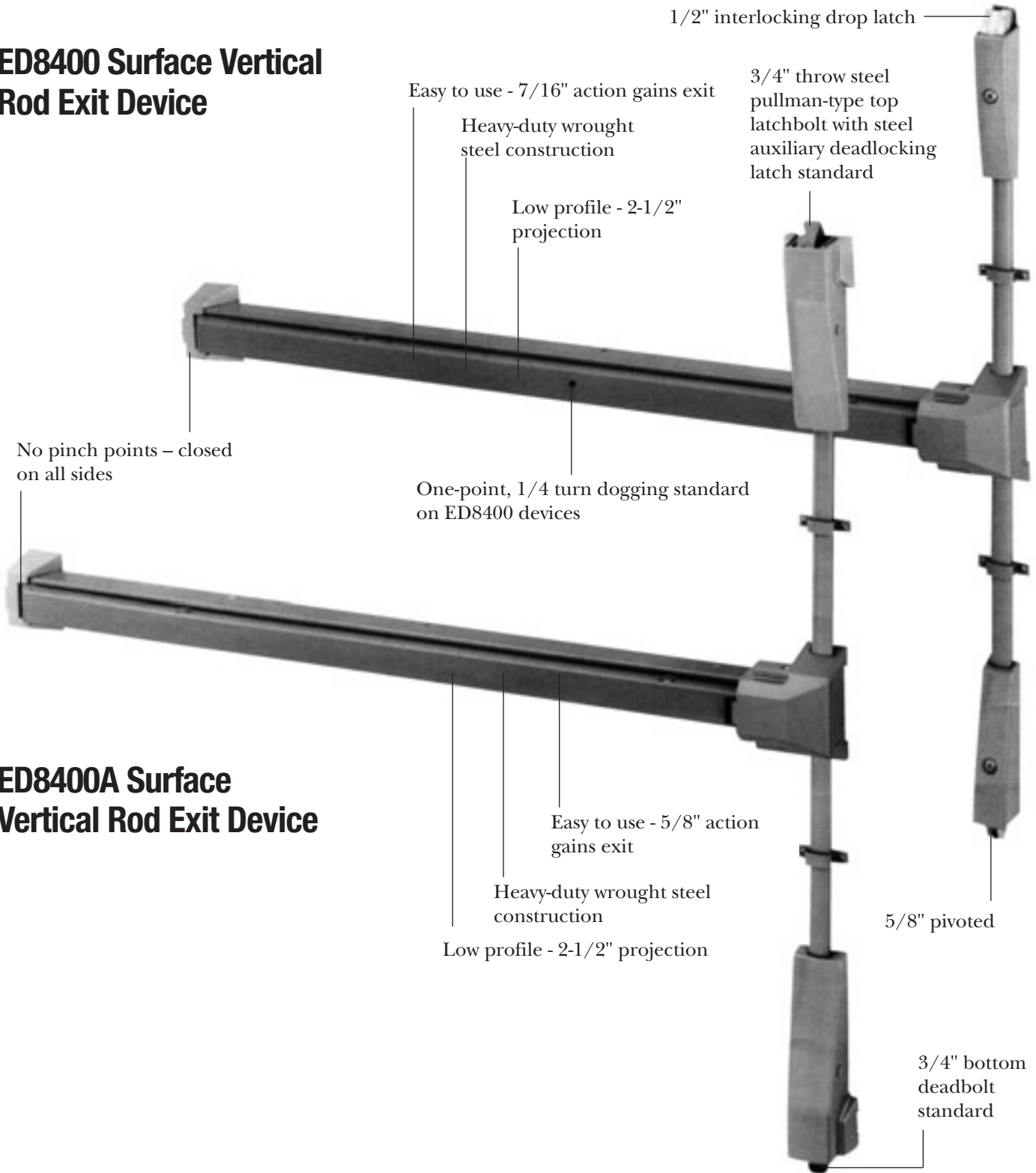





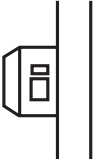

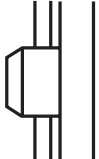



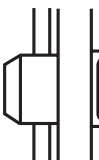

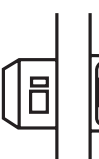

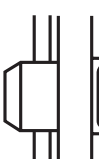

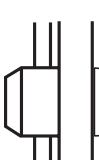

BHMA 626 Satin Chromium Plated

ED8400 Surface Vertical Rod Exit Device



ED8000 Series Pushpad Exit Devices









Functions

Rim ED8200 ED8200B ED8200A		Surface Vertical Rod ED8400 ED8400A		Type	ANSI No.	Functions Description
Inside	Outside	Inside	Outside			
				Exit Only	F01	- Exit only; no trim.
				Dummy	F02	- Entrance by trim when actuating bar is locked down.
				Nightlatch	F03	- Entrance by trim when latch bolt is retracted by key. Key removable only when locked.
				Classroom	F08	- Entrance by knob or lever. Key locks or unlocks knob.
				Passage	—	- Latch bolt retracted by grip.
				Storeroom (Lever Active)	F09	- Entrance by knob or lever only when released by key. Key removable only when locked.

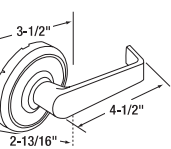

Indicates rigid grip when locked.

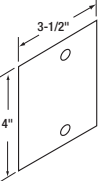
Note: Trims shown are for function representation only. See pages 9 and 10 for available trims.







Trim Design	Passage	Dummy ANSI No. F02	Classroom ANSI No. F08	Nightlatch ANSI No. F03	Storeroom ANSI No. F09
 <p>Armstrong A6 </p> <p>Lever: Die cast zinc Rose: Wrought brass or bronze Cylinder: Key-in-lever</p> 	A610	A650	A655	A657	A659
 <p>Newport N6 </p> <p>Lever: Die cast zinc Rose: Wrought brass or bronze Cylinder: Key-in-lever</p> 	N610	N650	N655	N657	N659
 <p>Princeton PR6 </p> <p>Lever: Die cast zinc Rose: Wrought brass or bronze Cylinder: Key-in-lever</p> 	PR610	PR650	PR655	PR657	PR659
 <p>Global G10</p> <p>Knob: Wrought Rose: Wrought brass or bronze Cylinder: Key-in-knob</p> 	G1010	N/A	G1055	N/A	N/A
 <p>Flat Plate F1</p> <p>Plate: Steel Cylinder: Rim Available in plated and painted finishes.</p> 	N/A	F150 ^{1,2}	N/A	F157 ²	N/A
 <p>Z-Pull P1 </p> <p>Pull: Extruded Cylinder: Rim</p> 	N/A	P150 ²	N/A	P157 ²	N/A

Notes:

- Blank plate with no ANSI function.
- Not recommended for use with ED8400 or ED8400A Surface Vertical Rod devices.

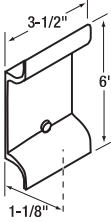
ED8000 Series Pushpad Exit Devices

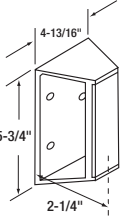
Trims and Functions

Trim Design	Passage	Dummy ANSI No. F02	Classroom ANSI No. F08	Nightlatch ANSI No. F03
 <p>Wing Pull P8 Pull: Extruded Cylinder: Rim Available in painted finishes only.</p>  	N/A	P850 ¹	N/A	P857 ¹
 <p>Offset Pull P2 Pull: Extruded Cylinder: Rim</p>  	N/A	P250 ¹	N/A	N/A
 <p>Key Only KO Cylinder: Rim</p> <p>Note: Available with cylinder option only. Ex: K057 x 6P</p> 	N/A	N/A	N/A	K057 ¹

Note:

1. Not recommended for use with ED8400 or ED8400A Surface Vertical Rod devices.

Rim Strikes (Screws Included)



Rim Strike

Standard on ED8200 and ED8200B devices. To order separately, specify 386F45.

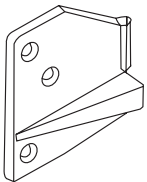

Rim x Vertical Rod Strike

Required for ED8200 devices when used on pair of doors with ED8400 device. To order with exit device, specify S02. To order separately, specify 468F30 x finish.

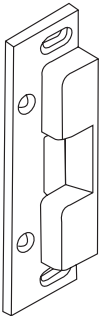

3-Hour Fire-Rated Rim Strike

Standard on ED8200A devices. To order separately, specify 518F06.

Shim Kits

For ED8200 & ED8200B
Part No. 557F928 622

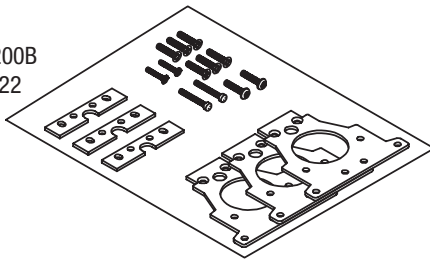

For ED8400
Part No. 557F948 622

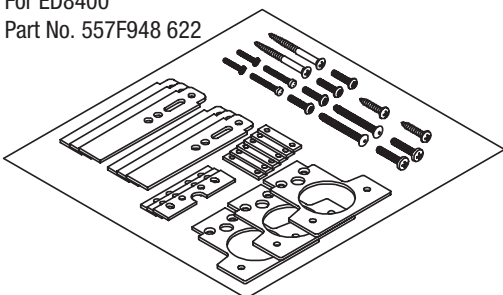

Vertical Rod Strikes (Screws Included)



Top Strike

Standard on ED8400 devices. To order separately, specify 446F21.

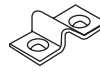

Surface Projecting Bottom Strike

Standard on ED8400 devices. To order separately, specify 446F22.

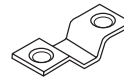

Flush Bottom Strike

Optional for ED8400 devices only. To order with exit device, specify S03. To order separately, specify 463F92.

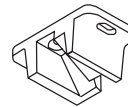

Fire-Rated Top Strike

Standard on ED8400A devices. To order separately, specify 526F52.

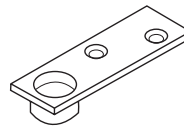

Fire-Rated Bottom Strike

Standard on ED8400A devices. To order separately, specify 526F53.

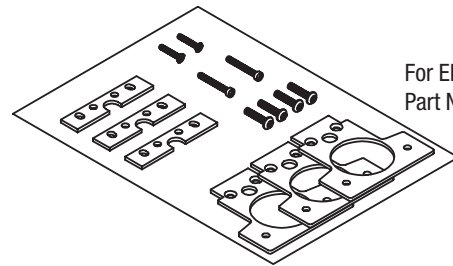

For ED8200A
Part No. 557F938 622

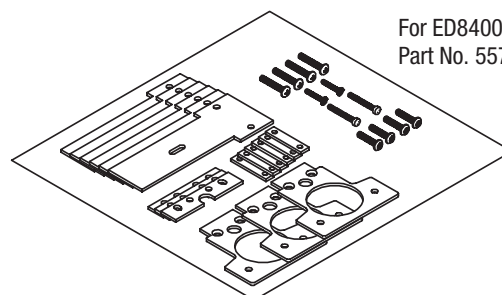

For ED8400A
Part No. 557F958 622

Cylinders

L4 keyway standard. To order with Exit Device, see Quick Codes, page 16. To order separately, specify Part No. x keyway x Finish (e.g., 2000-033-7 x L4 x 626).

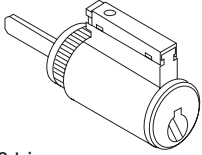
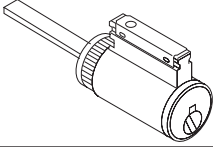
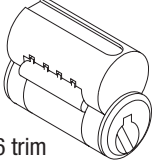
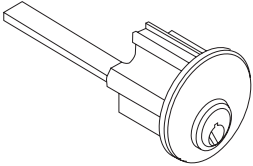
Cylinder Type	Part No.	Description
 <p>Key-in-Lever for A6, N6 and PR6 trim</p>	2000-033 2000-033-7 2010-033 2020-033	6-pin 7-pin 6-pin, Security 7-pin, Pyramid
 <p>Key-in-Knob for G10 trim</p>	2000-033H 2010-033H 2020-033H	6-pin, horizontal tailpiece 6-pin, Security, horizontal tailpiece Pyramid, horizontal tailpiece
 <p>Interchangeable Core Optional for A6, N6, PR6 trim</p>	8000 8000-7 8010 8020	6-pin 7-pin 6-pin, Security 7-pin, Pyramid
 <p>Rim for all other trim</p>	3000-200 3000-138 3000-200-7 3010-200 3012-178 3080-178 3070-178 3070-178-7 3080-178-7 3090-178 3020-200 3030-178 3080-114 3070-114 3080-114-7 3070-114-7 3020-138 3030-114	6-pin 6-pin, horizontal tailpiece for exit alarm supplied when M61 or M62 is ordered 7-pin, horizontal tailpiece 6-pin, horizontal tailpiece, Security 6-pin, blockout function, Security 6-pin, interchangeable core (IC) 6-pin, IC less core 7-pin, IC less core 7-pin, IC 6-pin, Security IC Pyramid 7-pin Pyramid, IC 6-pin, IC for exit alarm supplied when M61 or M62 is ordered 6-pin, IC less core for M61 or M62 7-pin, IC for M61 or M62 7-pin, IC less core for M61 or M62 7-pin Pyramid, horizontal tailpiece for exit alarm supplied when M61 or M62 is ordered 7-pin Pyramid, IC for exit alarm supplied when M61 or M62 is ordered

Compatibility with Competitive Cylinders (N6 and PR6 trims only)

Competitive Cylinder	Complete Trim	Parts for Field Conversion
Schlage® conventional 21-002, 23-001 or 23-013	Specify M06	682F39-8 Tailpiece
Schlage Primus 20-548, 20-550, 20-748 or 20-750	Specify M06	682F39-8 Tailpiece
Best® style core, 6 or 7-pin	Specify M08	Field Conversion Not Practical
Sargent® 13-3266	Specify M09	682F96-9 Tailpiece kit and Special Lever
Schlage IC Core	Specify M69	697F94-2 Tailpiece

For Assa and Medeco retrofit cylinders, consult those manufacturers' catalogs.

Removable Mullions

Used to install two ED8200, ED8200A or ED8200B Rim Exit Devices in a double door opening. May be quickly and easily removed when a full double door opening is temporarily required.

500 Series

Materials and Finish

Steel mullion, 2"x3" with malleable iron top and bottom plates; furnished with zinc plated fasteners for metal frames and concrete floors. May be cut, drilled and tapped in the field for Rim Exit Devices. Primed for painting, BHMA 600.

508 - 3-Hour Fire-Rated Removable Mullion

(ANSI Type 22)

Accommodates door openings up to 8' high, with or without threshold. (May be field cut for doors under 8'.)

UL

3-hour fire-rated by Underwriters Laboratories on A label and lesser class door openings up to 8' x 8'; UL label on mullion indicates listing.

510-Removable Mullion For Doors Up to 10'

(ANSI Type 22)

Used to install two ED8200 Rim Exit Devices in a panic listed double door opening up to 10'-high. (May be field cut for doors under 10'.)

Ordering

See How to Order, page 15.

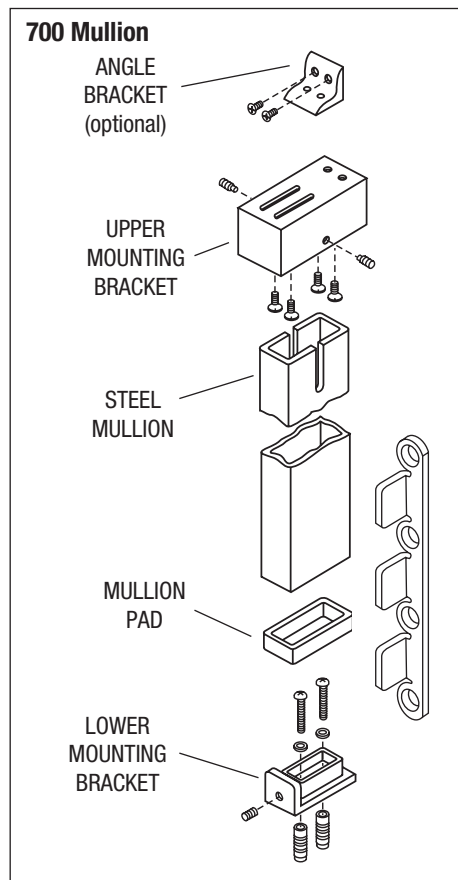
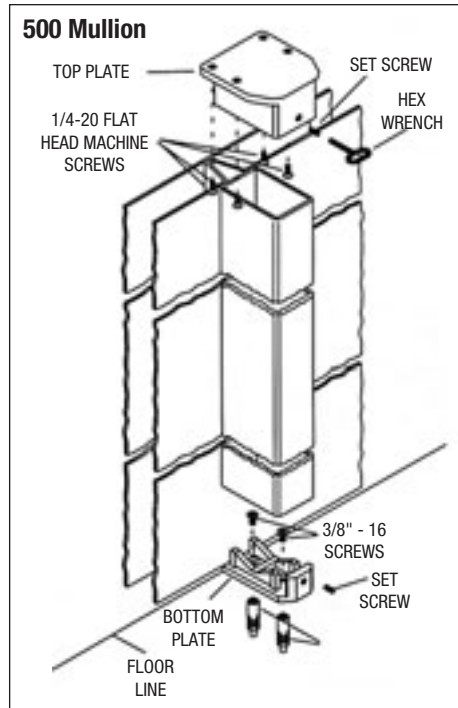

700 Series

Materials and Finish

Tubular steel mullions, 1-1/2" x 3", with malleable iron top and bottom mounting plates; furnished with zinc-plated fasteners for metal frames and concrete floors. May be cut, drilled and tapped in the field for Rim Exit Devices. Primed for painting, BHMA 600.

Keyed Removable Mullion

Designed for simple removal/re-locking when an unobstructed large opening is required. Mullion automatically re-locks when re-installed without the use of the cylinder key. To order with a mullion, specify quick code KM. To order the retrofit kit, specify KRM700A.

Spacer Block

Recommended for double rabbeted frames where the stop face width is less than the mounting hole spacing and also for door frames 5-3/4" (176mm) or less. To order with a mullion, specify M95. To order separately, specify Part No. 683F29-8.

Angle Bracket

Recommended for any header configuration with less than 3" (76mm) of mounting surface. To order with a mullion, specify M96. To order separately, specify Part No. 655F63-8.

Mullion Stabilizer Kit

Controls the movement of the mullion. Recommended for opening over 7' high, or whenever door movement must be minimized. To order with mullion, specify M57. To order separately, specify Part No. 653F11-1 x 695 or 628.

Ordering

To order, specify Part No.

Maximum UL Listing	Mullion Opening Height	Part No.
3-Hour	7'0"	707A
3-Hour	8'0"	708A
Panic Only	10'0"	710

Exit Alarm

Optional on ED8200 and ED8200B devices; emits audible alarm, signaling emergency or unauthorized use of door. To order, specify option M61.

Exit Alarm With 20-Second Delay

Optional on ED8200 and ED8200B devices; permits controlled authorized entrance or egress. For authorized exit, turn inside key to OFF, then back to ON. This allows 20-second interval to exit without sounding alarm. To enter, use key outside. Alarm will not sound if door is closed within 20 seconds. To order, specify option M62.



Features

Solid state circuitry with adjustable sensitivity.

Volume

85db at 10 feet.

Light Emitting Diode (LED)

Indicates power on, alarm on, delay feature on.

No wiring required

Recommended power source: one 9-volt alkaline battery (not included). One additional battery may be used for extended alarm.

Tamper resistant design

Will not obstruct emergency exit; provides easy access for battery changes.

Size

3-7/8" (98mm) x 9-3/4" (248mm) x 2-5/8" (67mm). 1-3/4" (44mm), 2" (51mm) and 2-1/4" (57mm) door thickness; 2-3/4" (70mm) backset.

Door Size

Standard 36" (914mm) exit device fits 31" (787mm) - 36" (914mm) doors. Optional: 30" (762mm) fits 28" (711mm) - 30" (762mm) doors; 42" (1067mm) fits 37" (940mm) - 42" (1067mm) doors; 48" (1219mm) fits 43" (1092mm) - 48" (1219mm) doors.

Non-handed

Warning decal

EMERGENCY EXIT ONLY- ALARM WILL SOUND. Applied in field; will not affect handing.

Inside cylinder

Rim. For keying options see page 16. To order cylinder separately, see page 12.

Keying

When alarm is ordered with exit device and outside trim, inside and outside cylinders will be keyed alike.

Trim

Available with all trims for ED8200 and ED8200B devices; see pages 9 and 10.

Retrofitting

To add standard alarm to existing device, order ED82AK x Finish. To add alarm with time delay to existing device, order ED82AK x M62 x Finish. To order time delay switch separately, specify 490F71 for all bar lengths.

Ordering Examples

Rim Exit Device

Quantity	Series/Function	Finish
20	ED8200	689

Removable Mullion

Quantity	Mullion
6	508

Rim Exit Device with Trim

Quantity	Exit Device	Trim/Function	Finish		Hand	Door Thickness	Door Width	Misc. Options
			Trim	Device				
65	ED8200A	A610	613	690	LHR	D200	W048	M58

Vertical Rod Exit Device with Trim

Quantity	Exit Device	Trim/Function	Finish		Hand	Door Thickness	Optional Strike	Door Width	Door Height	Misc. Options
			Trim	Device						
28	ED8400	N655	626	689	RHR	D214	S03	W048	H1000	M54

Contract/Detailed Order – Rim Exit Device with Trim

Quantity	Keyset	Exit Device	Trim/Function	Finish		Hand	Door Thickness	Door Width	Misc. Options	Optional Cylinder	Keying
				Trim	Device						
32	AA1	ED8200	P857	626	689	LHR	D200	W048	M54	C6	VKC3

Where to find ordering information and Quick Codes

Functions and Trims	Pages 8-10
Rim and Vertical Rod	Pages 13
Removable Mullion	Page 16
Finish	Page 16
Handing	Page 16
Door Thickness	Page 16
Strike	Page 16
Door Width	Page 16
Door Height	Page 16
Miscellaneous Options	Page 16
Cylinders and Keying	Page 16

Cylinders and Keying

Description	Specify
Conventional 6-pin	6P
Pyramid Security fixed core	PS
Pyramid Security IC	PCS
Pyramid High Security fixed core	PHS
Pyramid High Security IC	PCHS
Pyramid IC with temporary construction core	CTP
Pyramid IC with temporary disposable core	CTPD
Pyramid IC less core	CLP
Security IC	CHS
IC 6-pin*	C6
IC 6-pin with temporary construction core*	CT6
IC 6-Pin with temporary disposable core*	CT6D
IC 6-pin less core*	CL6
IC 7-pin*	C7
IC 7-pin with temporary construction core*	CT7
IC 7-Pin with temporary disposable core*	CT7D
IC 7-pin less core*	CL7
Blockout function	BO
0-Bitted with 2 blank keys	(standard)
Keyed random	KR
Master Keyed (all cylinders except 8000, 8020, 8027 IC core)	specify keyset
Master Keyed Pyramid	specify keyset
Master Keyed Security (including IC cylinder and core)	specify keyset
Master Keyed 8000, 8020, 8027 IC core	specify keyset
Master Keyed to customer bittings or sample key	specify keyset
Construction master keyed ¹	CMK
Visual key control (VKC)	
- No Stamping	VKC0
- Keys only	VKC1
- Cylinders and Keys ²	VKC2
- Cylinders only ²	VKC3
Concealed key control (CKC)	
- CKC cylinders with VKC keys	CKC2
- CKC cylinders only ²	CKC3

Notes:
 1. CMK construction master keying is not available in Pyramid or Security Series.
 2. VKC2, VKC3, CKC3 are not available in Pyramid or Security series.
 *Not available for G10 trim.

Finish

Description	Specify
US3 Bright Brass	605
US4 Satin Brass	606
US9 Bright Bronze	611
US10 Satin Bronze	612
US10B Dark Oxidized Satin Bronze, oil rubbed	613
US26 Bright Chromium Plated	625
US26D Satin Chromium Plated	626
Silver Aluminum Painted	689
Dark Bronze Painted	690
Light Bronze Painted	691

Door Thickness

Door	Specify
*1 ³ / ₈ " (35mm)	D138
1 ³ / ₄ " (44mm)	(standard)
2" (51mm)	D200
2 ¹ / ₄ " (57mm)	D214

*G10, A6, N6, PR6 series trims only.

Door Width

Door	Specify
30" (762mm)	W030
36" (914mm)	(standard)
42" (1067mm)	W042
48" (1219mm)	W048

Door Height

Door	Specify
7'6" (2.29m) (ED8400 devices)	(standard)
8'0" (2.44m) (ED8400A devices)	(standard)
10'0" (3.05m) (ED8400 devices only)	H1000

Handing

Hand	Specify
Right Hand Reverse	RHR
Left Hand Reverse	LHR

Miscellaneous Options

Description	Specify
Less cylinder, with tailpiece for Schlage® cylinder (N6 and PR6 trims only)	M06
Lever to accept Best® type core (N6 and PR6 trims only)	M08
Lever to accept Sargent® cylinder (N6 and PR6 trims only)	M09
Lever to accept Schlage IC core	M69
Knurling outside only (trim side)	M21
Abrasive coat outside and inside (trim and device)	M23
Abrasive coat inside only (device side)	M24
Abrasive coat outside only (trim side)	M25
Less dogging	M51
*Sex nuts and bolts (SNBs)	M54
Mullion stabilizer kit	M57
Shim kit (for vision light)	M58
Shim for 2-3/4" (70mm) backset on doors with 1/2" (13mm) stop (rim devices only)	M59
Exit alarm (rim devices only)	M61
Exit alarm with delay (rim devices only)	M62
Door frame filler block for double rabbited frames	M95
Door frame angle bracket for aluminum frames	M96
707A, 708A, 710 keyed removable mullions	KM

*Not available with D138 option.

Strike

Description	Specify
Rim	
Rim x vertical rod	S02
Vertical Rod	
Flush bottom (ED8400 devices only)	S03

Abrasive Coat

Hard granular material applied to provide a non-slip tactile surface for the visually impaired.

Active Door

In a pair of doors, the door that is operable from the trim side.

Astragal

A vertical member applied to one or both sides of a pair of doors at the meeting edges. The astragal closes the gap between the two doors.

Coordinator

A device used on a pair of doors to ensure that the inactive door closes before the active door.

Deadlocking Latch

A supplemental latch that automatically deadlocks the latchbolt when pressure is applied to it.

Dogging

A mechanism that allows the latchbolt to remain retracted, permitting the door to operate as if it were a push-pull; it cannot be used on fire-rated exit devices.

Double Egress

A pair of doors of the same hand that swing in opposite directions, commonly found in corridors.

Dummy Trim

Trim only. Usually used on the inactive door of a pair of doors for design balance.

Exit Device (Panic Hardware)

A door locking device with a pushpad or crossbar which, when pressed, allows instant exit (egress).

Fire Exit Hardware

An exit device listed by an independent testing laboratory as meeting panic, fire and hose stream test standards; used on fire-rated openings.

Hand

The direction a door swings.

Inactive Door

In a pair of doors, the door that is inoperable from the trim side.

Latchbolt

A lock component that has a beveled end and projects into a strike, holding the door in a closed position.

Mullion

A fixed or removable vertical member that divides a door opening and provides a latch surface for a pair of rim exit devices.

Narrow Stile Door

Usually a door having a stile less than 2-3/4" (70mm) wide, commonly seen on aluminum or glass front applications.

Shim Kit

Pieces of metal that permit mounting of an exit device on a door that has a surface projecting vision light (glass bead) moulding.

Split Astragal

An astragal that is split through the middle on a pair of doors, allowing both doors to operate independently.

Threshold

A strip fastened to the floor beneath a door. It serves as a stop, prevents heat loss, and provides a strike location for latching the bottom rod of a vertical rod exit device.

Trim

A knob, lever, pull, or thumbpiece used on the outside of an exit device door to control access to an area.

Universal Exit Device

An exit device that may be used on doors of either hand without any modifications.

Keying and Cylinder Terms**Blockout Cylinder**

A cylinder which allows all keys to be temporarily blocked from operating. It is set by a blockout key.

Concealed Key Control (CKC)

The marking of standard key symbols on a cylinder in a location which is not visible once the cylinder

Suggested Specification

All exit devices shall be ED8000 Series Pushpad Exit Devices as manufactured by Corbin Russwin Architectural Hardware.

The maximum exit device projection shall be 2-1/2" (64mm). The exit device bar shall be constructed of heavy wrought steel. The pushpad shall be constructed of wrought steel; scalped pushpads or pushpads with plastic or Lexan coatings shall not be acceptable. The pushpad shall cover the entire length of the devices. Pushpads which cover less than the entire length of the device shall not be acceptable. Nylon bearings and stainless steel springs shall be used for long life and durability; only torsion springs are acceptable. All device covers shall be of aluminum; plastic or metal stamping shall not be acceptable. Mounting screws shall be concealed to deter tampering. All ferrous parts shall be zinc coated to prevent rusting.

Single point, one quarter turn hex key dogging shall be standard on non-fire-rated devices.

All devices shall be listed by Underwriters Laboratories for safety as panic hardware. Fire rated devices shall be UL/C-UL listed for A label and lesser class doors, 4' x 8' single and 8' x 8' pair. The model number shall be located on the endcap; devices having the model number located other than on the endcap shall not be acceptable.

On trims with cylinders, the locking and unlocking of the trim shall be housed in the trim and not in the active head of the device. Trim shall be throughbolted and fasteners shall be concealed.

All trims shall be furnished in architectural finishes and shall match the trims and finishes on corresponding locksets.

Certification:
ANSI A156.3, Grade 1

All devices, trims and cylinders shall be from one manufacturer.

All devices and trims shall carry a one-year limited warranty.

For more information regarding Corbin Ruswin Locksets,
Exit Devices, Door Controls and Key Systems, contact your
authorized Corbin Ruswin Distributor or Sales Representative.



In U.S.:
Corbin Ruswin, Inc.
1902 Airport Road
Monroe, NC 28110
Phone 800-543-3658
Fax 800-447-6714
www.corbinruswin.com

In Canada:
Yale-Corbin Canada Ltd.
6940 Edwards Boulevard
Mississauga, ONT L5T 2W2
Phone 800-461-3007
Fax 800-461-8989
www.yalecorbin.on.ca

The ASSA ABLOY Group is the world's leading manufacturer and supplier of locking solutions, dedicated to satisfying end-user needs for security, safety and convenience.

Corbin Ruswin and Design® is a registered trademark of Corbin Ruswin Inc. These materials are protected under US copyright laws. All contents current at time of publication. Other product brand names may be trademarked or registered trademarks of their respective owners and are mentioned for reference purposes only. Copyright© 2002, 2004, Yale Security Inc. All rights reserved. Corbin Ruswin, Inc. reserves the right to change availability of any item in this catalog, its design, construction, and/or its materials.